



DeepBrain Chain

# DBC Cloud GPU Computing Power Service

2023.06



Deep Brain Chain - Distributed high-performance computing network based on blockchain technology

Most important infrastructure in the era of **AI+Metaverse**

**Stabel, Delay-free cloud GPU computing services** based on a high-performance and large-capacity.

**NO.1**

World's first

**1400+GPU**

Mainnet  
computing power  
resource

High-performance  
computing power  
network

Blockchain  
mainnet

GPU computing  
power mainnet

**10+Nodes**

Multiple worldwide  
computing nodes

**10000+Users**

Computing power resource adopted  
by users in large scales on the  
ground

## 6 Features of the Cloud Computing Network

DeepBrain Chain on totally **open-source network**

Build **own cloud platform** based on the DeepBrain Hash Network

### Multiple machine models



- DeepBrain Chain Skynet's AI training GPU resources are abundant, you can choose from 1 GPU to 128 GPU and switch at any time.

### Flexible supply



- Uses elastic expansion technology to realize automatic container deployment, and quickly copy and distribute containers to multiple idle nodes during traffic peaks.

### Low cost



- Through its unique token economic model, mining nodes are encouraged to provide cheap computing power resources, reducing the training cost of AI manufacturers up to 30% of the original cost.

### P2P



- It matches the computing power resources of computing power demanders and computing power providers, and users do not need to bear intermediate costs.

### Distributed – edge computing power



- Large-scale distributed computing power is seamlessly applied and managed in a decentralized manner, providing users with edge computing power. It realizes user information data security through blockchain technology.

### Supports multiple frameworks



- DBC AI computing power network supports many training frameworks, currently supports TensorFlow, Caffe2, PyTorch, MXNet, CNTK, H2O.

# PC market trends – rising demand for high-performance cloud computing power

High-performance and cloud PCs are essential in start-ups, medical care, education, game in the 4<sup>th</sup> industrial revolution

Rapid growth of the **high-performance GPU** server market after the launch of the **ChatGPT** in 2022,

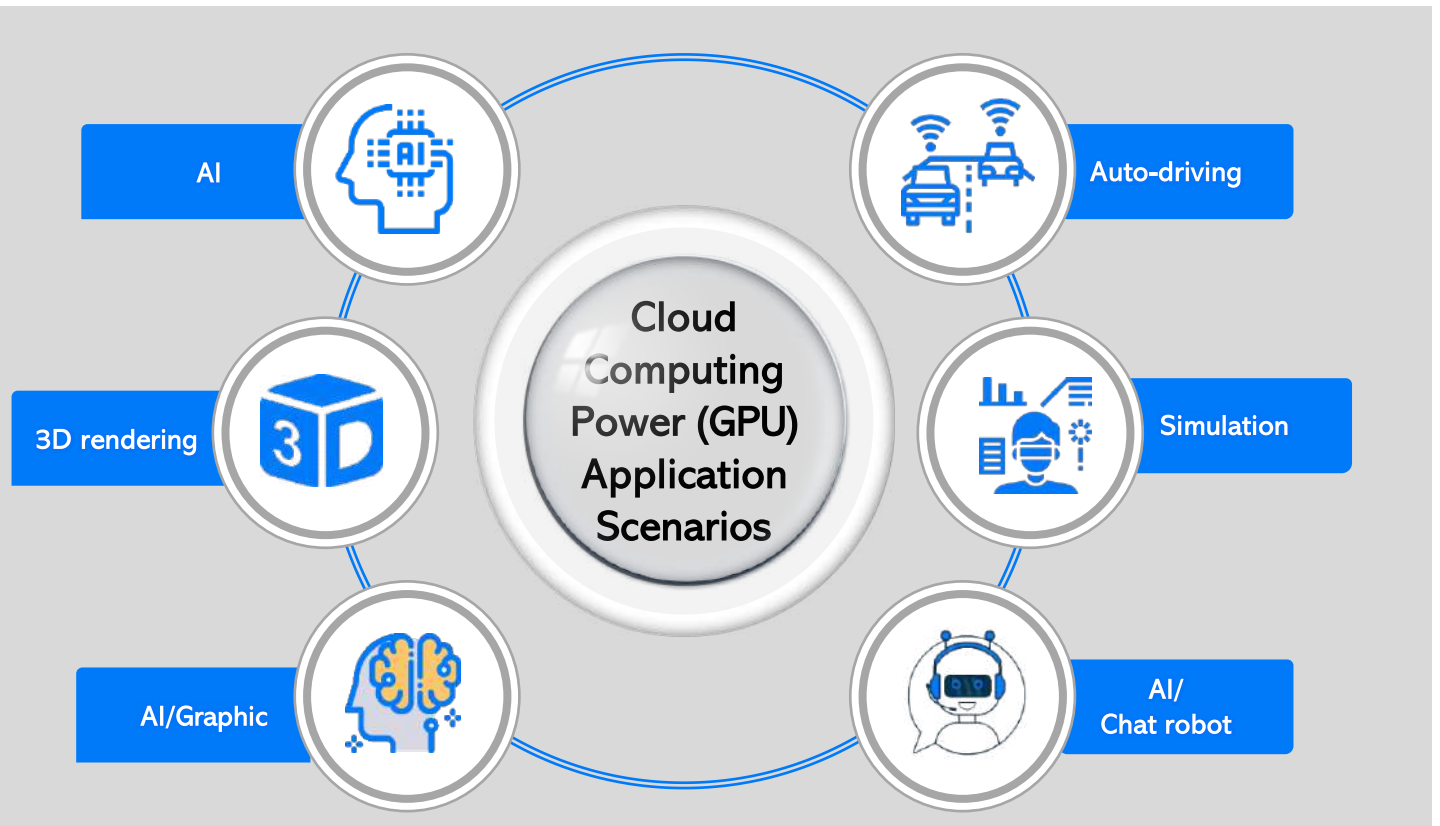

# Games market trends – from content to platform

## The emergence of rental cloud games

- Easy access to high-performance games at low cost with the technological development, 5G network and the cloud computing
- Cloud gaming is a service that utilizes streaming technology.
- Stability is improved according to network performance without delay
- **Cloud gaming** is becoming more popular as PC costs increase along with **GPU prices**.

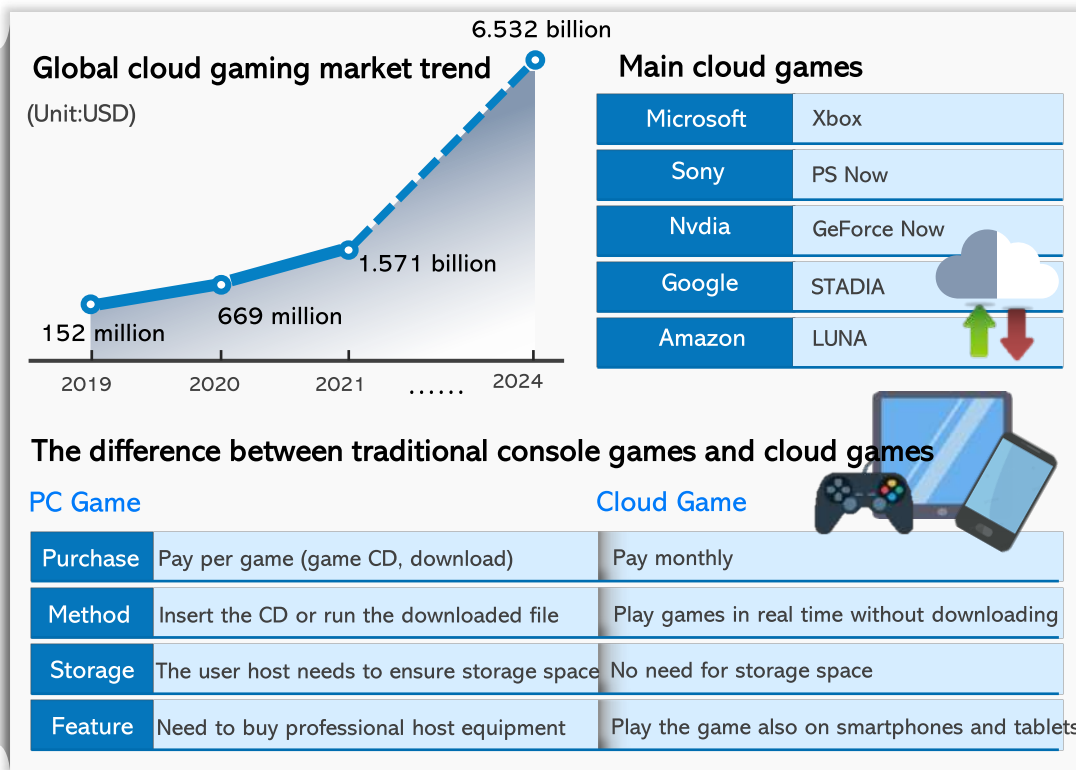
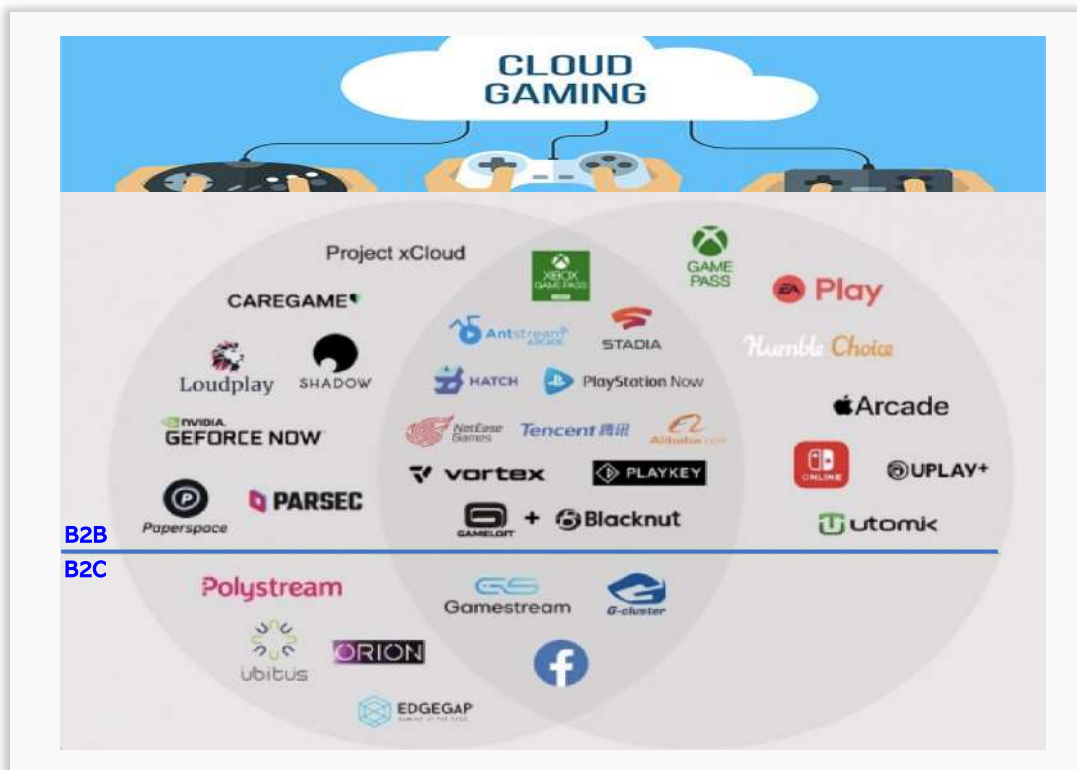

# DBC Cloud computing power – High-performance PC computing power service

DBC Cloud Center provides **high-performance GPU computing** through a **dedicated platform**

- Providing various GPUs, allocating local resources, based on low-latency/high-performance network
- Flexibility to use anywhere, anytime with global GPU rental platform

## DBC Cloud Platform



Cloud-end(edge)configuration  
(data distribution, 30Km service)



## DBC network(Korea)

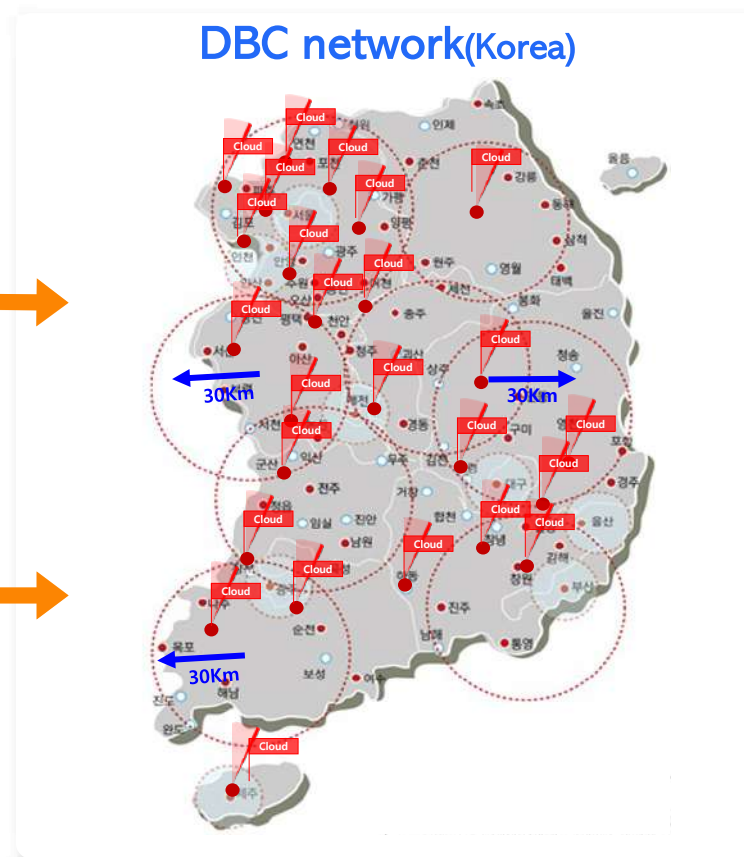

# DBC Cloud computing power – service structure

Automated cloud computing for service types such as B2B and B2C and franchises

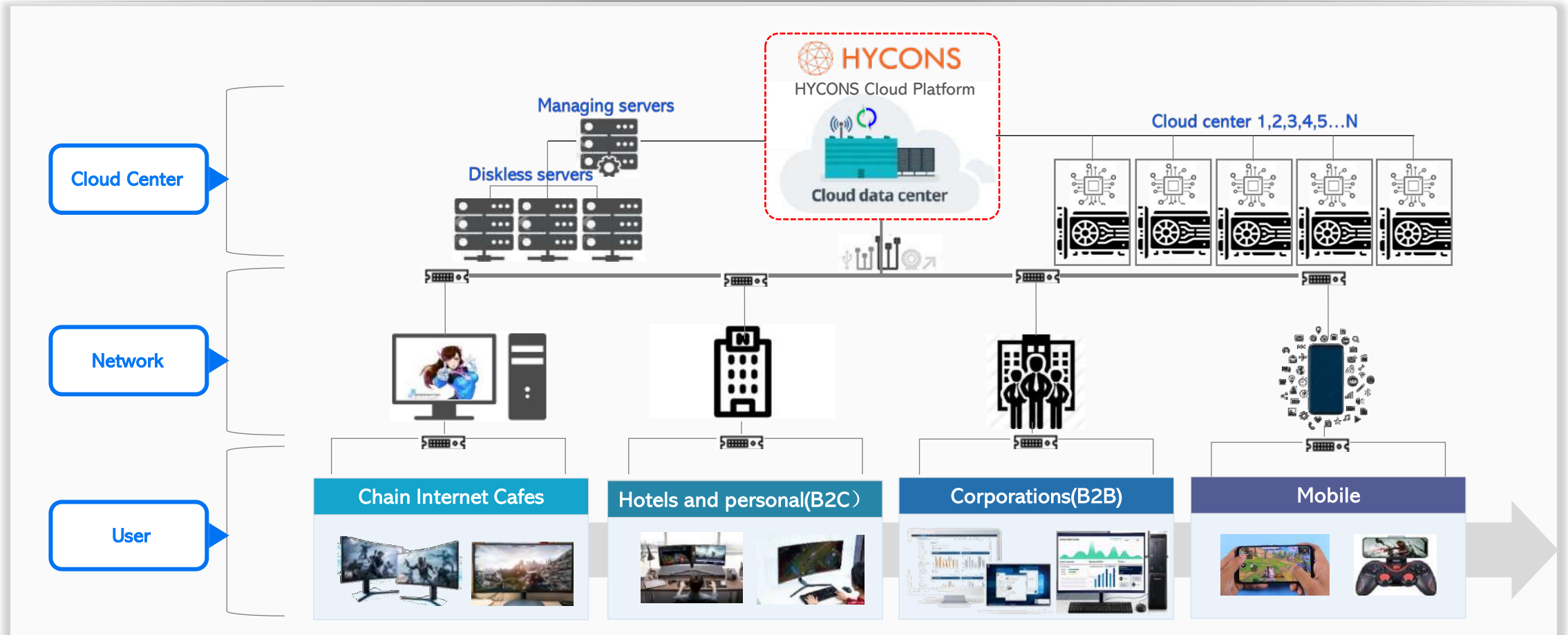

# DBC cloud computing power businesses(service advantage 1)

World-class **high-definition streaming technology** / e-sports level technology and **cost-competitive service**

Automatic transfer of services in case of cloud center failure (power supply, network, Internet, etc.)

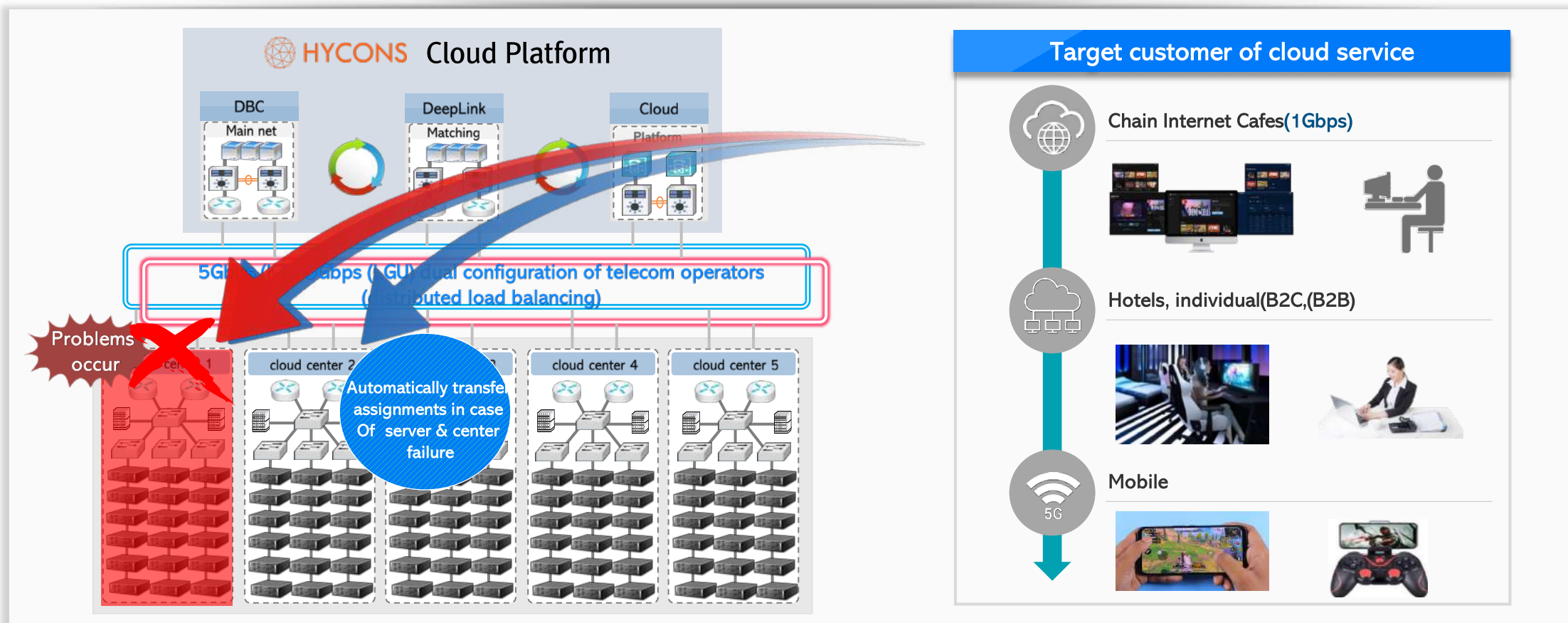



# DBC cloud computing power businesses(service advantage 2)

Guaranteed excellent compression technology, fast response time, high-definition frame and stable data transmission

## DBC Cloud Center

DBC Data center 1



DBC Data Center 2



DBC Data Center 3



### DBC Cloud center services and features

- 1 Lossless compression technology, low cost
  - World-class codec technology
  - Through 95% NAT, 10Bit transmission
  - Minimized network bandwidth (FHD 15-20Mbps)
- 2 High frame rate, speed and fast response time
  - 4K 240Hz frame technology
  - LAN delay up to 15ms, packet loss rate up to 5%
  - Optimized for High Performance Gaming
- 3 HD (4K QFHD 3840\*2160 transmission)
  - Use AI algorithm technology to enhance visual effects when transferring large-capacity data
  - Restore the most original color function
- 4 Reliable data transmission
  - Packet loss and overload prevention technology when handling large amounts of data
  - Automatic distribution processing technology when packet loss or overload occurs
  - Apply streaming media optimization technology to support 5% packet loss and 100ms network delay
  - Still supports high frame rate speeds
- 5 High security
  - All data adopts DTLS1.2 encryption technology through AES256

### Cloud service target customer



Chain Internet Cafes(1Gbps)



Hotels, individual(B2C),(B2B)



Mobile



# DBC Cloud Computing Power - Cloud IDC

Korea DBC Data Center 1 (SERVER 100SET / GPU Card 400EA 2022.06 in operation)

### 1. Drawings, floor construction

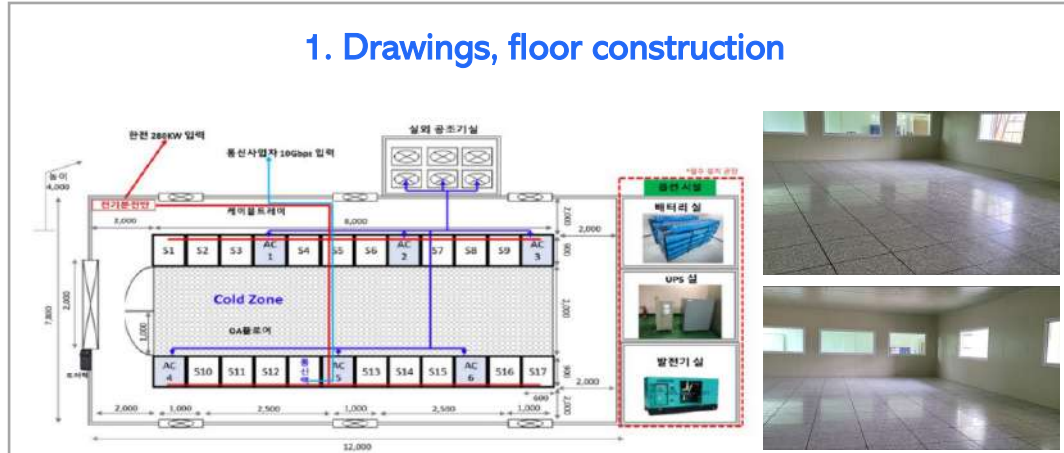

### 2. Server rack construction



### 3. Network (electrical appliance) & GPU server

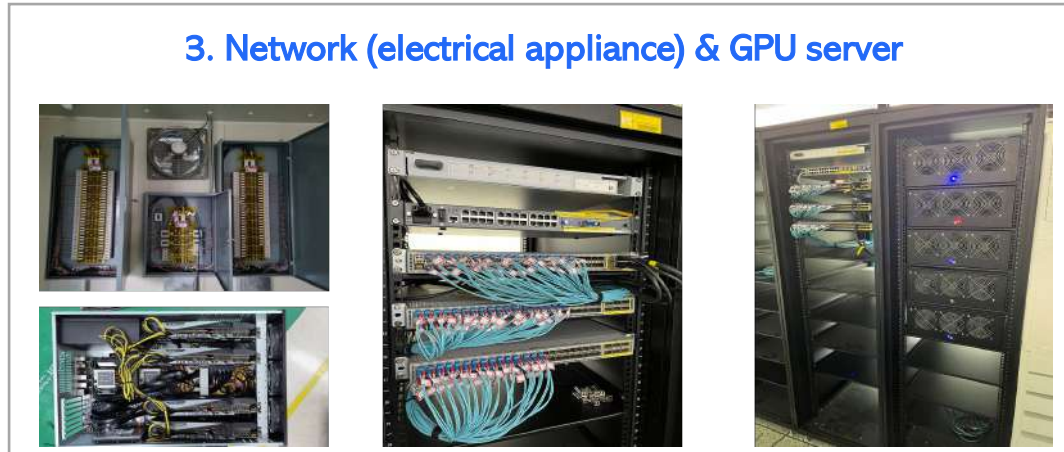

### 4. Cloud computing power data center



# DBC Cloud computing power – IDC schematic diagram

Stable and guaranteed network and hardware configuration

\* IDC Recommends T3 level

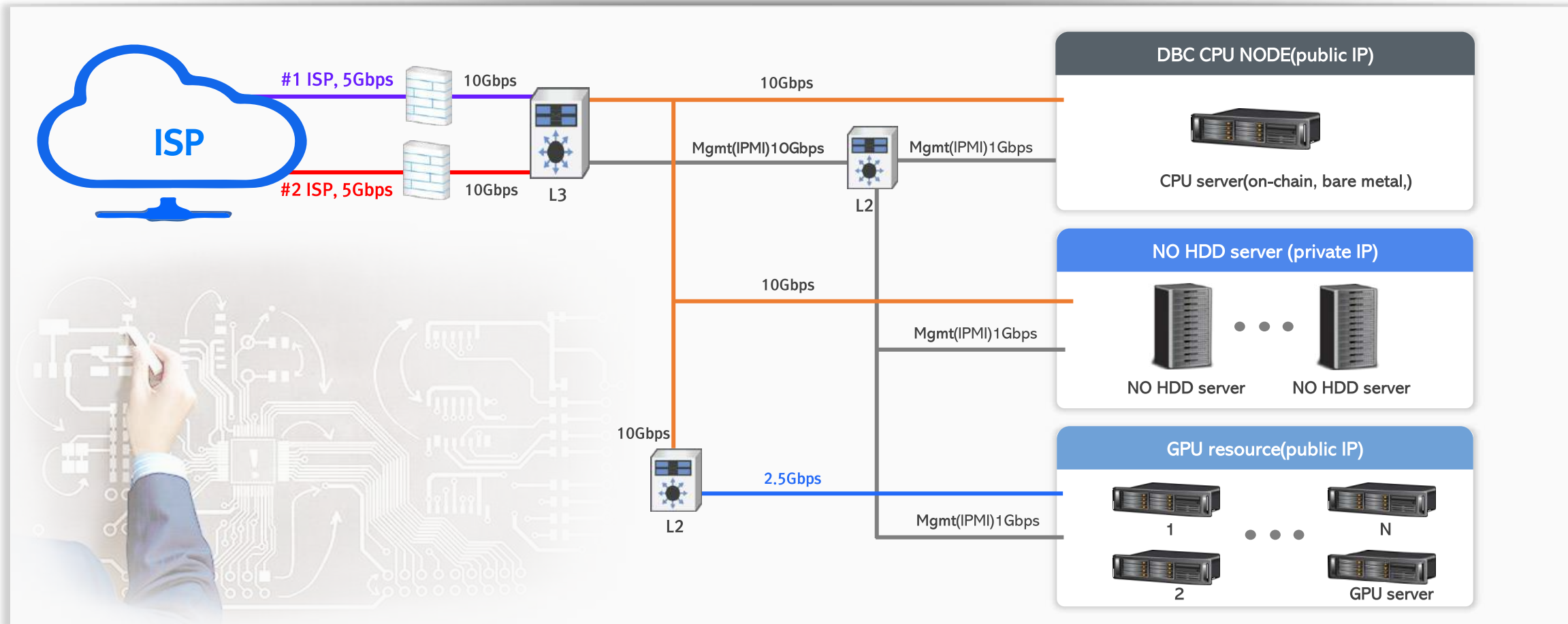

# DBC Cloud computing power - IDC resource configuration(1)

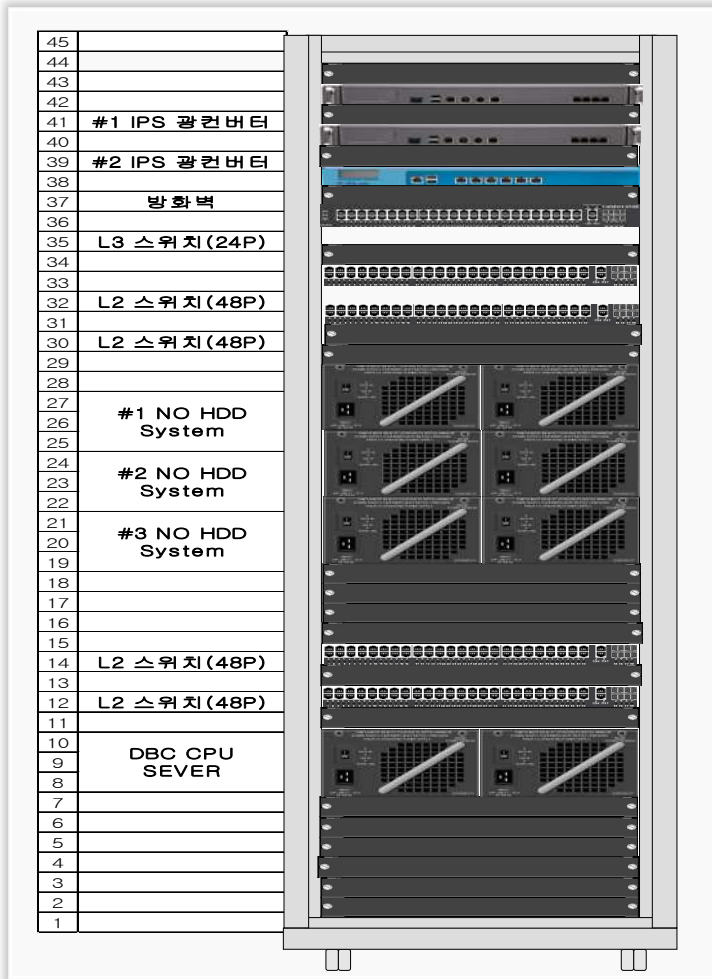

## Network/Diskless System/DBC CPU Server

Allocation	Specification	Main function	Amount	Note	
1 cabinet (19" /45U) Internet equipment	Cabinet	size	600mm(width) X 2200mm(height) X 650mm(thick)	1	
	Optical transceiver	for fiber optic cable	#1.#2 Configured separately for each ISP operator (5Gbps x 2)	2	
	Firewall		Firewall&IPS&IDS	1	
	switch	L3	10Gbps 10Gbps SFP 24 API	1	
Server	switch	L2	10Gbps 48 API (UP 10Gbps/下 10Gbps)	4	
	diskless server #1.2.3	CPU	Intel® Core™ i7-11700/k/ kf 16 core 3.6-5 GHz	1	3 sets are required (500 sets as a benchmark)
		System disk	256G M.2/ Nvme	1	
		Data disk	GAME:2TB(Stripe),NO HDD OS IMG:256GB, WriteBack : 256GB	1	
		RAM	32G DDR4	1	
		motherboard		1	
		network card	10 Gbps SFP	1	
		power supply		1	
	DBC CPU server	CPU	Intel® Core™ i9-13900/k/ kf 16核3.1-5.5 GHz	1	need 1 set (DBC mainnet chain)
		System disk	1TB M.2/ Nvme	1	
Data disk			1		
RAM		64G DDR4	1		
motherboard			1		
network card		10 Gbps SFP	1		
power supply		1			

# DBC Cloud computing power - IDC resource configuration(2)

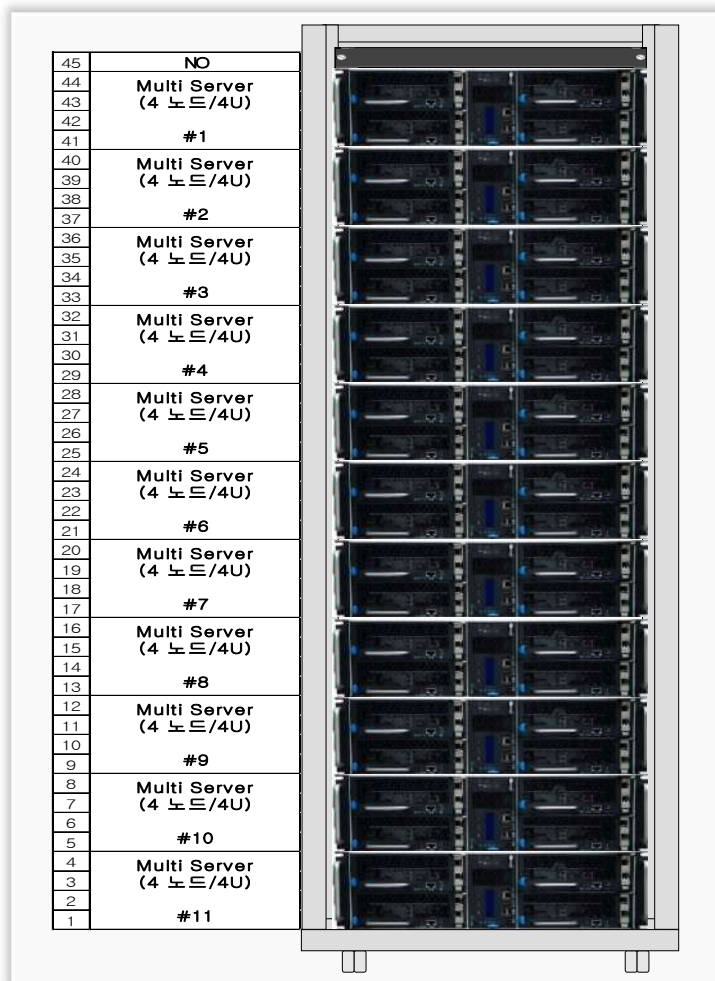

Multi-card server (4 nodes) specifications (compatible with GPU 20xx, 30xx, 40xx series)

Allocation	Specification	Main function	Amount	Notes	
1 cabinet (19" /45U)	cabinet	size	600mm(width) X 2200mm(height) X 650mm(thick)	1	
	Server number	4 nodes	44 blades system	11	9 recommended Power 21.6Kw
	GPU number	RTX-3090	1 sheet per 1 blade system	44	
	Total power supply	26.4Kw	2.4Kw (GPU 3090 4 pieces) CRPC module per 1 blade system	4	Power supply Line 2
Multiple server (4nodes/4U) YW3044	blade system (2U)	CPU	Intel® Core™ i9-12900/k/ kf 16core3.1-5.5 GHz	4	
		System disk	one M.2 PCIe4 4.0 NVME API		
		Data disk	one 2.5inch SSD SATA3.0 disk API		
		RAM	DDR4 32G/64G According to the memory type of the motherboard	4	
		motherboard	ITX(170X170mm),network (RJ-45) 2.5Gbps x1, M.2 x1, SATA x1, USB3.0 API x1, USB2.0 API x2	4	
		Network card	1Gbps/2.5Gbps/10Gbps single-port or dual-port network card can be connected externally		
		GPU	RTX-3090 (compatible with 30xx,40xx series), (360x165x70mmxlea)	4	
bare metal system	Power supply	AC 220~240VAC. (9.5A, /50~60Hz) CRPS supply device (1600W). 2 for main use (1~2 for backup, optional)	2/4	support hot swap	
	cooling system	Each blade system corresponds to each cooling fan attachment	4		
	shell	Standard 4U chassis, blade system standard 2U chassis (4 pieces)	1		
	Management system	Network (RJ-45) 1Gbps, blade system remote VNC management support, support IPMI2.0 (power ON/OFF, power consumption setting, temperature, fault alarm, power consumption measurement, BIOS and Windows remote update, IP change, etc.)	1	management network need to be configured separately	

# DBC Cloud computing power – IDC resource configuration(3)

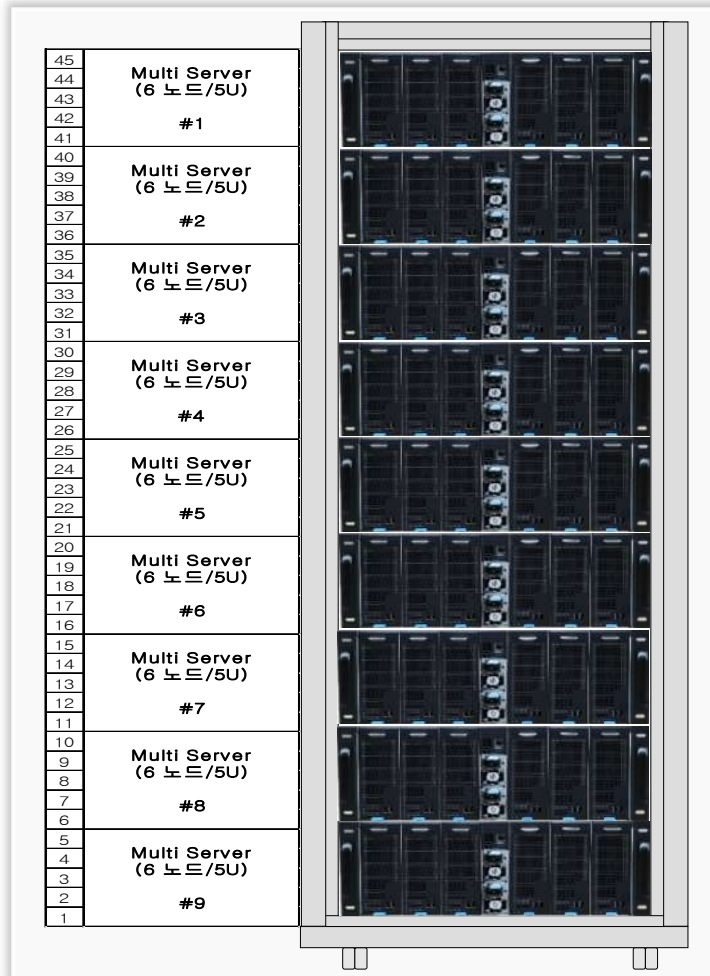

Multi-card server (6 nodes) specifications (compatible with GPU 20xx, 3060, 3070 series)

Allocation	Specification	Main function	Amount	Notes	
1 cabinet (19" /45U)	cabinet	size	600mm(width) X 2200mm(height) X 650mm(thick)	1	
	Server number	6 nodes	54 blades system	9	7 recommended Power 16.8Kw
	GPU number	RTX-3060	1 sheet per 1 blade system	54	
	Total power supply	26.4Kw	2.4Kw (GPU 3060 6 pieces) CRPC module per 1 blade system	4	Power supply Line 2
Multiple server (6nodes/5U) YW5066	Blade system (5U)	CPU	Intel® Core™ i9-12900/k/ kf 16 core 3.1-5.5 GHz	6	
		System disk	one M.2 PCIe4 4.0 NVME API		
		Data disk	one 2.5inch SSD SATA3.0 disk API		
		RAM	16G/32G DDR4	6	
		motherboard	M-ATX(240x205mm), network(RJ-45) 2.5Gbps x1, M.2 x1, SATA x2, USB API x2	6	
		Network card	1Gbps/2.5Gbps/10Gbps single-port or dual-port network card can be connected externally		
		GPU	NVIDIA RTX-3060 (compatible with 20xx, 3060, 3070 series), (360 X165X70mm 1 sheet)	6	
bare metal system	Power supply	AC 220~240VAC. (9.5A, /50~60Hz) CRPS supply device (1300W), 2 for main use (1~2 for backup, optional)	2/4	support hot swap	
	cooling system	Each blade system corresponds to each cooling fan attachment	6		
	shell	Non-standard 5U chassis, blade system chassis (6 pieces)	1		
	Management system	Network (RJ-45) 1 Gbps, supports IPMI 1.0 (power on, off, blade reset, etc.)	1	management network need to be configured separately	

# DBC Cloud Computing Power – Computing Power Resource Specifications

Multi-card server (4 nodes, 4U) product image (compatible with GPU 20xx, 30xx, 40xx series)



Front

Model: YW3044



back

1. 4U rack server, 445(W)x176(H)x800(D)mm
2. 4 hot-swappable computing power nodes
3. Support 1+1, 2+0, 2+2 redundant power supply mode
4. Support IPMI2.0, support IPMI web management page
5. Support KVM over IP (based on VNC)
6. Support remote system upgrade
7. CRPC power module (1300W, 1600W, 2000W) xN (N=1, 2, 3)

Inside



1. Support 12th-13th generation Intel CPUs with a maximum TDP of 200W or above
2. Support standard CPU cooler with 2U height
3. Support 350x70x145 mm large graphics card
4. Support one 2.5" SATA SSD
5. Support 1 NVME SSD
6. Support external network card
7. Support ITX motherboard (170x170mm)

**average power usage**

1. RTX3060/3070. (600W)
2. RTX3080/3090. (800W)
3. Intel CPU average value. (300W)

Multi-card server (6 nodes, 5U) product picture (compatible with GPU 20xx, 3060, 3070 series)



Front

Model: YW5066



Back

1. 5U rack server, 445(W)x220(H)x770(D)mm
2. 6 hot-swappable computing power nodes
3. Support 1+1, 2+0, 2+2 redundant power supply mode
4. Support IPMI1.0, support IPMI web management page
5. CRPC power module (1300W, 1600W, 2000W) xN (N=2, 3, 4)

Inside



1. Support the 12th-13th generation Intel CPU with a maximum TDP of 150W or less
2. Support standard CPU cooler with 1.5U height
3. Support 350x55x145 mm large graphics card
4. Support one 2.5" SATA SSD
5. Support 1 NVME SSD
6. Support external network card
7. Support M-ATX (240x205mm) and ITX (170x170mm)

Login Package

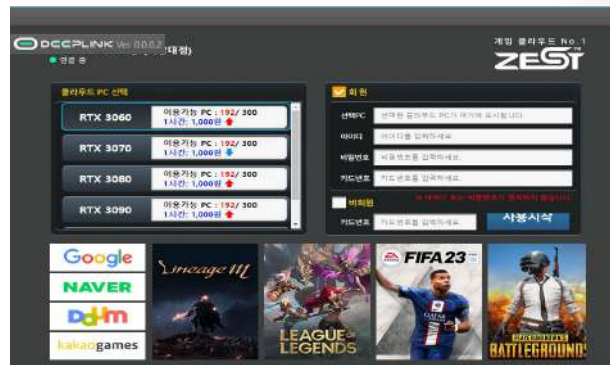

A-TYPE Mini PC



Type	Specific ation	Main functions
A-TAPE (Mini PC)	configur ation	Monitor + Mini PC
	CPU	Intel Alder-Lake N100 (3.4GHz)
	GPU	Intel®UHD显卡(750 MHz)
	MEM	8G (DDR4/3200MHz)
	SDD	128GB
	USB	USB 3.0x2. USB 2.0x2
	HDMI	HDMI 2.0x2 (4096x2160@60Hz)
	LAN	RJ-45 (2.5Gbps)
	Power	AC/DC 220V 50/60Hz. 12V 2A Adapter

B-TYPE all-in-one



Type	Specific ation	Main functions
B-TAPE (All-in-one) SG3151D04-3	configur ation	Monitor IPS(31.5" ),UHD(3840x2160), 240Hz), 16:9
	performa nce	1ms(MPRT).GTG 1ms,DCI P3 90%,win10/11, built-in speaker 3Wx2
	CPU	Intel Alder-Lake N100 (3.4GHz)
	GPU	Intel®UHD GPU(750 MHz)
	MEM	8G (DDR4/3200MT/s)
	SDD	128GB
	USB	USB 3.0x2, 2.0x2 Audio Jacksx2,
	HDMI	HDMI 2.0x1 (4096x2160@60Hz)
	LAN	RJ-45 (2.5Gbps), Wi-Fi 2.4G~5GHz, Bluetooth
	Power	AC/DC 220V 50/60Hz. 19V/4.5A Adapter



Starting from the first phase of Internet cafes in 2023, enter the market in **four phases**

**Phase 1**

Enter Internet Café market

**Phase 2**

Enter hotels market

**Phase 3**

Enter individual and corporation market

**Phase 4**

Enter mobiles market

**The Current Situation of Internet Cafes in the Country and the Concentration in the Metropolitan Area**

- 94.5% of Internet cafes across the country have an average daily utilization rate of less than 40%
- 8,287 Internet cafes nationwide / 3,765 Internet cafes in the metropolitan area
- The first goal in 2023. Approximately 50 Internet cafes nationwide including Seoul, Gyeonggi, and Incheon
- Each data center has a scale of 500 to 1,000 to provide computing services
- The goal is to establish 10 IDCs by the first half of 2024 (serving about 80-100 Internet cafes)
- Small-scale establishment of IDC centered in Seoul

**National Hotel Industry Distribution**

- Fields of use that require cloud services. Hotels (hotel business)
- About 17,700 hotels in China / about 400,000 accommodation rooms. (Based on couple rooms, the cloud PC market is expected to be 800,000 units)
- Serving the national hotel market in 2024
- Expect slightly fewer complaints compared to Internet cafes
- Implementation of national installation services through B2B agents

**Current status of major shared office tenants**

- Shared offices are mainly settled by IT and advertising companies
- Cost reduction effect on PC procurement for start-ups and SMEs
- More and more start-up companies are biased towards practicality, and it is expected that cloud computing services will be favored
- B2C, B2B services through network marketing
- The market size is about 2 million users

**The total number of monthly active users of the overall mobile game APPs**

- The domestic mobile game market will reach 5,329.1 billion won in 2020
- Onestore continues to expand its market share with explosive growth
- Top 10 sales and mobile game markets dominated by role-playing
- 26.47 million people play mobile games every month, more than half of them are women
- The total number of users is mostly puzzles/questions and answers, and the time spent is mainly role-playing

# The Value of Cloud Internet Café Solutions – South Korea

Maximize profit margins for internet cafés with low cost and unlimited scalability

Continuing electricity price hikes

New GPU Cards Released such as RTX-40XX

Demand for an increase in internet cafe usage fees

Declining internet cafe sales due to various environmental factors

### Four major problems of existing Internet cafes

#### 1 Electricity bill burden

- Raise electricity tariffs in accordance with government policies



#### 2 CPU/GPU upgrade burden

- Every time a new GPU release comes with the burden of expensive GPU upgrade purchases

#### 3 Payment method awareness

- In order to change the fixed awareness that payment is limited to less than 1,000 won
- Need a reason to change the status quo

#### 4 Low utilization rate of PCs in Internet cafes

- Due to the pandemic, weather, etc., fewer users go to Internet cafes
- There is a problem with disposing of idle computers

## Cloud Internet Cafe Chain Store (Entrepreneurship)

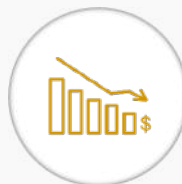

Reduce the burden of PC procurement costs  
Start-up costs reduced by up to 61%



Provide high-performance computing power  
Ultra-low latency game response speed



Maintenance fees “0 Won”  
No desktop management costs



Increase in turnover  
Set payment standards according to GPU models  
All seats can be set as premium areas



Energy saving and carbon reduction  
Save electricity bills and reduce carbon emissions



Pc upgrade fee “0 Won”  
CPU/GPU upgrades are completed in the cloud center



Cloud Internet Cafes Values

Reduce start-up costs and maintenance costs, without additional upgrade costs, providing the best economic benefits for Internet cafe owners



DeepBrain Chain

# Thank You

[www.deepbrainchain.org](http://www.deepbrainchain.org)

M



 HYCONS